

**D&L Ridemaster Bogies**

**Davis & Lloyd  
Ridemaster Bogies  
Price £16.00**

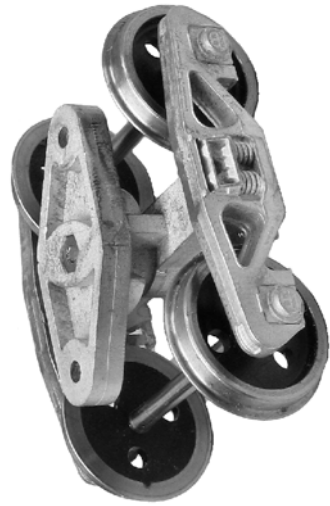

Modern design of bogie used on BR brake fitted wagons 1960 onwards. Designed for 3'1" wagon wheels (eg Slater's, 3 hole disc, 7122). Mounting & Swivel Fittings Included

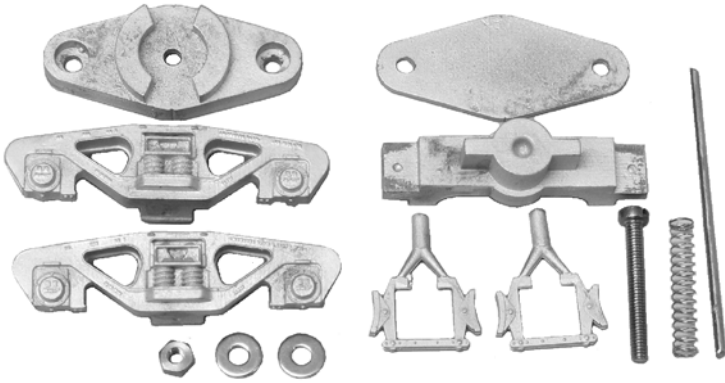

**Parts Identification For Each Individual Bogie.**

Bogie is designed for 3'1" wagon wheels and should accommodate those produced by a number of manufactures, Peartree, Markits, Peco, etc. My preference is for Slater's, Ref 7122.

*(Construction photos show diamond frame bogie. Ridemaster construction is identical)*

**Step 1**

Drill hole to accommodate chosen bearings. (2.6mm Ø for Slaters). Frequently offer bearing into hole to determine depth.

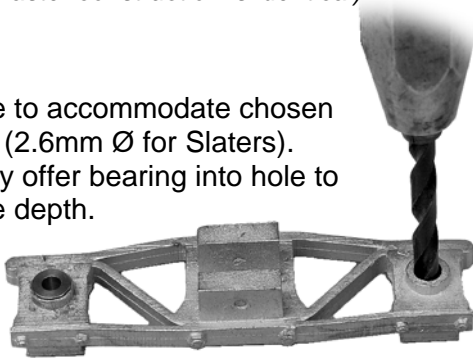

Hold drill in hand pin chuck for maximum control to help prevent breaking through axlebox front.

**Step 2**

Drill 1.6mm Ø holes for assembly pins.

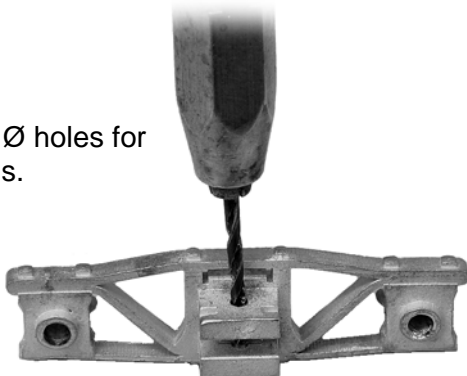

Drill & break through from top and then bottom. Then gently run drill right through to align both holes.

**Step 3**

Test assemble bogie, pressing side frames onto axle ends.

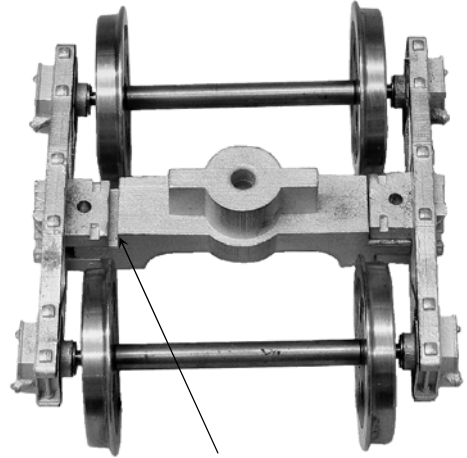

Note gap on stretcher when using Slater's wheelsets. My preferred solution is to reduce axle width by filing off the pin points (plus a couple of strokes) with a flat file.

**Step 4**

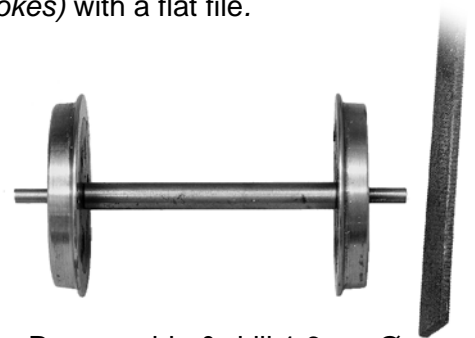

Reassemble & drill 1.6mm Ø hole down & through stretcher, aligning all holes.

**Step 5**

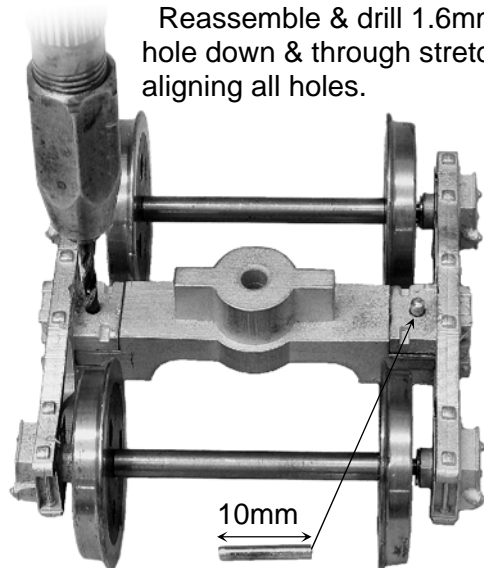

Cut from brass rod & fit assembly pins .

10mm

## Step 6

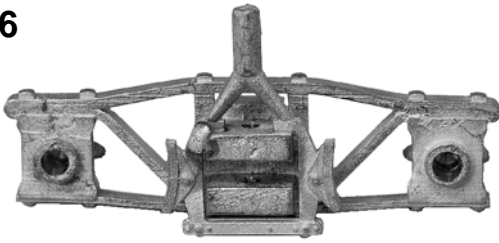

When happy with basic bogie, disassemble & fit brake yoke using a single tack solder joint.

## Step 7

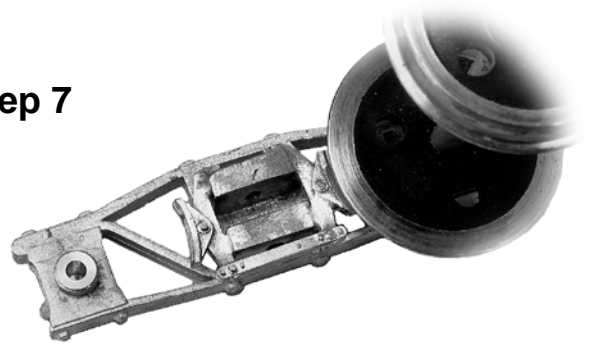

Offer up wheelset to check clearance. Make adjustments as required (*possibly chamfer brake block rear with knife blade*). When happy solder solid & clean up. Ensure rebate for stretcher end is clean & clear.

## Step 8

Make pin holes in stretcher ends slightly oversize (1.7mm Ø or wobble the drill in the hole a bit). Ensure easy fit of ends into sideframe rebates.

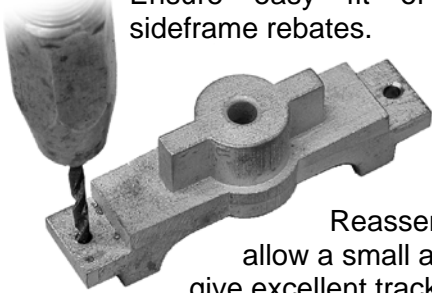

Reassembly with pins will allow a small amount of compensation to give excellent track holding. I secure the pins using a matchstick end to place a small blob of Araldite around their top ends.

## Step 9

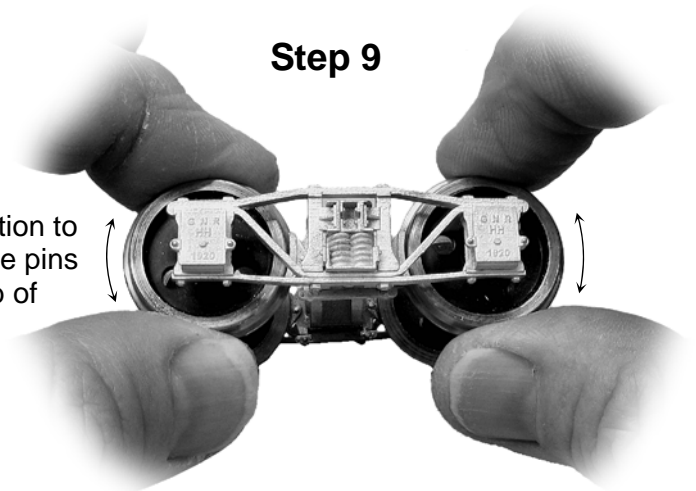

## Step 10

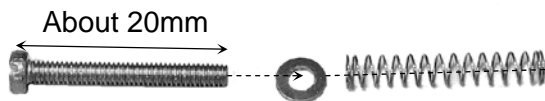
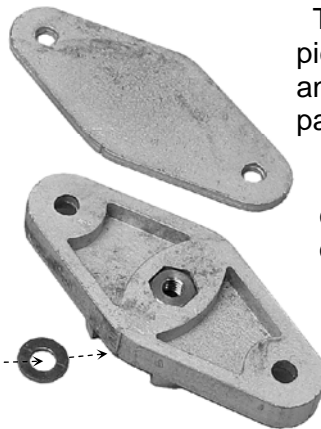
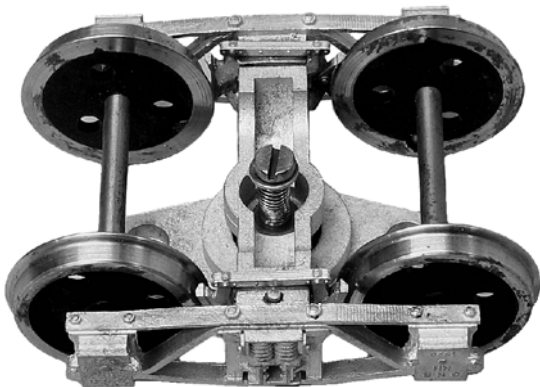

To attain correct buffer height the packing piece may be required between swivel unit and vehicle floor or use as template to cut packing from thinner material.

Note centring marks at corners of castings to allow accurate positioning onto marked centrelines on wagon floor.

If desired secure nut into rebate with a little Araldite dabbed onto flats. A little Evostick on the screw end will provide a threadlocker.

## Connoisseur Models

Proprietor  
Jim McGeown  
1 Newton Cottages  
Nr Weobley  
Herefordshire  
HR4 8QX  
01544 318263

